

JONIX

pure living

JONIX cube

USE AND MAINTENANCE MANUAL



JONIX cube
BASIC version

JONIX cube
IOT version



AIR PURIFICATION DEVICE
WITH ADVANCED COLD PLASMA TECHNOLOGY



These instructions are the translation of the italian original ones. No liability is taken for translations into other languages that do not conform to the original meaning. JONIX S.p.A. reserves every right concerning this manual, including the right to make any necessary change or improvement to its products and to the manual at any time and without notice. It is forbidden to reproduce in full or in part this manual without JONIX S.p.A.'s consent.

TABLE OF CONTENTS

1 - GENERAL INFORMATION (BASIC and IOT version)	5
1.1 - CE PLATE AND SERIAL NUMBER	5
1.2 - RESPONSIBILITY	5
1.3 - GENERAL SAFETY INDICATIONS, SYMBOLS AND DEFINITIONS	6
1.3.1 - General safety information	6
1.3.2 - Symbols	6
1.3.3 - Definitions	7
2 - WARNINGS AND GENERAL PROHIBITIONS (BASIC and IOT version)	8
3 - THE OPERATING SYSTEM (BASIC and IOT version)	11
4 - TECHNICAL DATA JONIX cube (BASIC and IOT version)	12
4.1 - COMPONENTS DESCRIPTION JONIX cube	12
4.1.1 - Technical characteristics JONIX cube	13
4.1.2 - Spare parts available on order	13
5 - RECEPTION, TRANSPORT AND STORAGE (BASIC and IOT version)	14
5.1 - PACKAGING	14
5.2 - HANDLING AND TRANSPORT	15
5.3 - INSPECTION UPON RECEPTION	15
5.4 - STORAGE	15
5.5 - HANDLING DEVICE IN OPERATING CONDITIONS	15
6 - INSTALLATION AND COMMISSIONING (BASIC and IOT version)	16
6.1 - SAFETY INSTRUCTIONS	16
6.2 - GETTING STARTED	19
6.3 - OPERATING SITE CHARACTERISTICS	19
6.3.1 - Position of the operator	19
6.4 - ELECTRICAL CONNECTIONS	20
6.5 - ELECTRIC POWER SUPPLY	20
6.6 - USING THE DEVICE	20
6.7 - CONTROL PANEL JONIX cube (BASIC version)	22
6.7.1 - Operating levels (BASIC version)	23
6.7.2 - Ventilation function (BASIC version)	23
6.8 - CONTROL PANEL JONIX cube (IOT version)	24
6.8.1 - Operating levels (IOT version)	25
6.8.2 - Ventilation function (IOT version)	25
6.9 - FIRST START CHECKS	26
7 - REMOTE MANAGEMENT WITH IoT SYSTEM	26
7.1 - INTRODUCTION	26
7.2 - REGISTRATION AND LOGIN	27
7.2.1 - Main screen (without associated device)	27
7.3 - DEVICE ASSOCIATION	28
7.3.1 - Main screen (with associated device)	29
7.3.2 - Virtual buttons	29
7.3.2.1 - Timing level	29
7.3.2.2 - Maintenance Status	30
7.3.2.3 - Programming Status	30

7.4 - PROGRAMMING	31
7.4.1 - Adding a programming	31
7.4.2 - Copying a programming	32
7.5 - SETTINGS	32
7.5.1 - Information Screen	33
7.5.2 - Maintenance Screen	33
7.5.3 - Program Screen	34
7.5.4 - Advanced Screen	34
7.6 - TROUBLE-SHOOTING	34
8 - MAINTENANCE (BASIC and IOT version)	36
8.1 - WARNINGS	36
8.2 - ROUTINE MAINTENANCE	36
8.2.1 - Cleaning the ionising tubes	37
8.2.2 - Cleaning the filter	41
8.2.3 - External cleaning of the device	43
8.2.4 - Replacing ionising tubes	43
8.2.5 - Replacement of the protection fuse	46
8.3 - SPECIAL MAINTENANCE	46
9 - OPERATIONAL CHECK AND TROUBLESHOOTING (DIAGNOSTICS)	47
9.1 - DIAGNOSTICS (BASIC and IOT version)	47
9.2 - DIAGNOSTICS (IOT version)	48
9.3 - GENERAL DIAGNOSTIC PROVISIONS	48
10 - DISPOSAL	49

Thank you purchasing the JONIX cube device.

This manual contains the information and anything deemed necessary for the transport, installation, use and maintenance of the active sanitizing and air purification device JONIX cube. Improper installation of the device and/or failure to comply with the instructions in this manual, may void the warranty that the Manufacturer issues for its products.

This device has been designed for use in civil environments only. The Manufacturer is not liable for any direct and/or indirect damage caused by incorrect installation. At the time of purchase, check that the device is intact and complete.

The Manufacturer declines any liability in case of personal injury or property damage resulting from any improper use of the device or from the failure to observe the use and safety instructions specified in this manual. In any such case, any warranty claim will be void.

Any complaints must be submitted in writing within **8 days** of receiving the goods.

1 - GENERAL INFORMATION (BASIC and IOT version)

1.1 CE PLATE AND SERIAL NUMBER

The device described in this manual is provided with a nameplate identifying it and the Manufacturer.

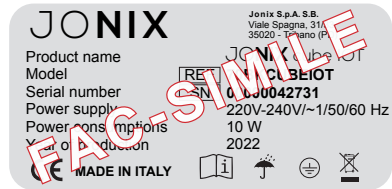

IMPORTANT WARNING

The JONIX cube device is designed and made to sanitise the air in civil environments that are incompatible with toxic and flammable gases. It is therefore strictly forbidden to use the device in environments where the air is mixed with and/or altered by other gaseous compounds and/or solid particles. Using the device for purposes other than those intended and that do not comply with those described in this manual will immediately relieve Manufacturer and its distributors from any direct and/or indirect liability.

1.2 RESPONSIBILITY

Failure to comply with the instructions contained in this Use and Maintenance Manual releases JONIX S.p.A. from any liability. For any data not included or not deducible from the following pages it is recommended to consult JONIX S.p.A. directly.

JONIX S.p.A. Benefit Corporation
 Viale Spagna 31/33
 35020 Tribano - PD - Italy
<http://www.jonixair.com>

In particular, if the maintenance of the device is carried out in a manner that does not comply with the instructions provided, or in any case in such a way as to compromise its integrity or modify its characteristics, JONIX S.p.A. will be relieved of any responsibility regarding the safety of persons, property, animals and the faulty operation of the devices.

1.3 GENERAL SAFETY INSTRUCTIONS, SYMBOLS AND DEFINITIONS

1.3.1 General safety instructions

Any intervention, of whatever nature, on the device must be carried out by prior and careful reading of this manual in all its parts, with particular reference to SAFETY.

It is essential, therefore, that the device is used in accordance with its intended use and with this manual. This manual has been drawn up to provide the necessary information for the use and maintenance of the device, until its sale or disposal. Before using the device, please read this entire manual carefully and keep it for future references.

1.3.2 Symbols

Please pay utmost attention to the following symbols and their meaning. They emphasise specific information, such as:



OBLIGATION: This symbol draws attention to a specific obligation or action to be implemented with obligation.



WARNING: It refers to integrations or suggestions concerning the proper use of the device.



HAZARD: It refers to dangerous situations that may result from the use of the device, in order to ensure personal safety.



FORBIDDEN: This symbol refers to operations that must be avoided under any circumstances, and hence forbidden.



HIGH VOLTAGE HAZARD!

Do not open or remove any doors or protections before disconnecting the voltage supply.



OBLIGATION TO USE PROTECTIVE GLOVES

Use adequate hand protection in addition to other personal protective equipment suitable for the place and the operations to be carried out.



WASTE ELECTRICAL AND ELECTRONIC EQUIPMENT.

The crossed-out bin symbol on the label on the appliance indicates that this product complies with the regulations on waste electrical and electronic equipment. The abandonment of the equipment in the environment or its unauthorised disposal is punishable by law.

1.3.3 Definitions

Below are the definitions of the main terms used in the user manual.

MANUFACTURER

Individual or juridical person who designs and/or manufactures the device and is responsible for its conformity for the purpose of placing it on the market under his own name or trademark.

SUPPLIER/DEALER

Professional operator in the marketing chain.

USER

Person, organisation or company who or which has purchased or rented the device and is going to use it for the intended purposes.

USER/OPERATOR

Individual who has been authorised by the user to operate the device.

QUALIFIED STAFF AUTHORIZED BY JONIX S.p.A.

Individuals who, on the basis of their professional training, experience, knowledge of relevant regulations and accident prevention regulations, are able to assess the work entrusted to them and recognize and avoid any hazards. The assignment to carry out certain activities derives from the authorization of JONIX S.p.A..

ROUTINE MAINTENANCE

Type of maintenance interventions during the life cycle, suitable for:

- maintain the original integrity of the goods;
- maintain or restore the efficiency of the goods;
- contain the normal degradation of use;
- ensure the useful life of the goods;
- cope with accidental events.

SPECIAL MAINTENANCE

Type of non-recurring and high cost interventions, compared to the replacement value of the goods and the annual cost of routine maintenance of the same.

NON THERMAL PLASMA GENERATOR NTP (Non Thermal Plasma) or IONIZING TUBE

Electric field generator that transforms gas into plasma with high chemical oxidation power able to oxidize and break down pollutants, bacteria, moulds, viruses and odours.

2 - WARNINGS AND GENERAL PROHIBITIONS (BASIC and IOT version)



READ THE INSTRUCTIONS BEFORE ANY OPERATION

Before starting any operation, it is mandatory to read this manual and apply all its instructions.



This Use and Maintenance Manual is an integral part of the device and must therefore be kept with care and must ALWAYS accompany the device even if it is transferred to another owner or user or transferred to another facility. In case of damage or loss, request another copy from JONIX S.p.A. or download the document from www.jonixair.com.



It is the user's responsibility to ensure that, if this document is modified by JONIX S.p.A., only the updated versions of the Manual are actually present at the points of use.



Repair or unscheduled maintenance work must be carried out by specialised personnel authorised by JONIX S.p.A. Do not alter or tamper with the device as it can lead to hazards and the manufacturer shall not be liable for any damage caused.



The transport, handling, installation, commissioning and decommissioning of this product must only be performed in accordance with the requirements and instructions specified in this manual.



Any liability of JONIX S.p.A. is excluded for damage caused to persons, animals or property, whether due to transportation, installation, adjustment, maintenance, decommissioning or misuse.

Please note that the use of products that require electricity involves the observance of some crucial safety rules such as:



This device is not intended for use by people with reduced physical, mental or sensory abilities or lack of experience and knowledge.



This device is not a toy, make sure it is placed out of the reach of children and take precautions so that children do not play with the device.



Cleaning and maintenance intended to be carried out by the user must not be carried out by unsupervised children.



Do not touch the device if you are barefoot and with parts of the body that are wet or damp.



Any maintenance or cleaning operation before disconnecting the device from the power supply is prohibited.



It is forbidden to modify the safety and/or adjustment devices.



Do not pull, detach or twist the electrical wires coming out of the device, even when it is disconnected from the mains.



It is forbidden to get on and/or sit on the device. It is forbidden to place objects, animals or people on the device.



It is forbidden to spray or throw water or other liquids directly inside the device, even in case of fire.



It is forbidden to use the device outdoors or on wet surfaces. Do not expose to water, rain or weathering.



It is forbidden to open the access panels to the internal parts of the unit without removing the power supply and making sure that the unit cannot be accidentally powered.



It is forbidden to use the device with a damaged cable or plug.



It is forbidden to use the device if it does not work properly, has received a strong blow, has been accidentally dropped, has been damaged or left outdoors or has fallen into water.



It is forbidden to insert objects into the openings of the device.



Do not dispose of or leave the packaging material within reach of children because it can be potentially dangerous.

For the maintenance and cleaning operations (see chapter 7 "Maintenance") of the device we remind you that:



ATTENTION!

BEFORE CARRYING OUT ANY MAINTENANCE OPERATION MAKE SURE THAT THE DEVICE IS NOT AND CANNOT ACCIDENTALLY BE POWERED ELECTRICALLY. YOU MUST THEREFORE UNPLUG THE DEVICE BEFORE CARRYING OUT ANY MAINTENANCE.

- It is the duty of the user to perform all the maintenance operations on the device reported in this manual.
- If a malfunction not indicated in this manual occurs, disconnect the power supply to the device and consult your dealer and/or JONIX S.p.A.
- Only specialised personnel authorized by JONIX S.p.A., can perform maintenance operations other than those specified in this manual.



For all maintenance operations it is good practice to use work gloves to protect your hands.

- Clean the ionising tubes every time it is shown on the display.
- Do not put back the mesh on the ionising tube if it is even partially wet.
- Check that the earthing spring is in contact with the outer mesh once the ionising tube have been screwed back into place. Otherwise contact the manufacturer.
- Do not use liquid cleaners, sprays, soap or other products directly on the device.

3 - THE OPERATING SYSTEM (BASIC and IOT version)

Among the wide range of air ionisers available on the market, the JONIX cube ioniser is a top of the range device that combines high performance and a modern and attractive design.

This sanitizing device, exploiting the physical phenomenon of ionization, promotes the controlled formation of particular electrically charged species in the air through an electrostatic field. The latter simulates a natural process that normally occurs through solar radiation, mechanically or by other physical phenomena.

The particular ionic species produced are proven to be particularly effective as sanitizing agents in air and on surfaces, moreover they are scientifically and historically proven to be beneficial on people, especially the negatively electrically charged species (i.e. those derived from single or small groups of molecules receiving an electron).

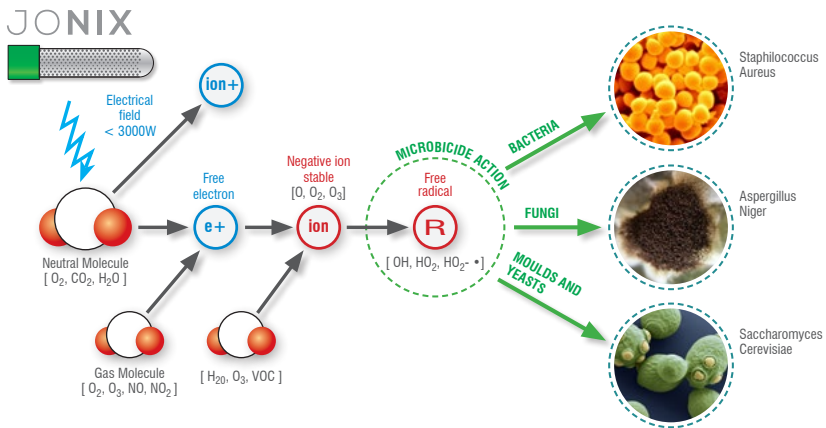

JONIX cube:

- constantly reduces and eliminates bacterial loads in the air and on indoor surfaces;
- constantly decomposes volatile organic compounds (VOCs);
- it eliminates odours;
- is suitable for environments that need to reduce air contamination.

The sanitizing activity of JONIX cube is compatible with the presence of people and animals. No chemicals are used and no harmful residual substances are generated.

Immediately operational, it does not require any set-up for its installation; it is the ideal solution to improve the hygiene of air and of surfaces, the environmental comfort of professional activities with high attendance such as pharmacies, medical clinics, hairdressing salons and beauty centres and schools and is suited to all those environments where it is necessary to guarantee continuous sanitisation activities even during the activities.

The device has a safety switch, positioned in such a way that when the protection cover (also accidental) is opened, the power supply to the ionizing units and the fan is removed.



4 - TECHNICAL DATA JONIX cube (BASIC and IOT version)

4.1 COMPONENT DESCRIPTION JONIX cube

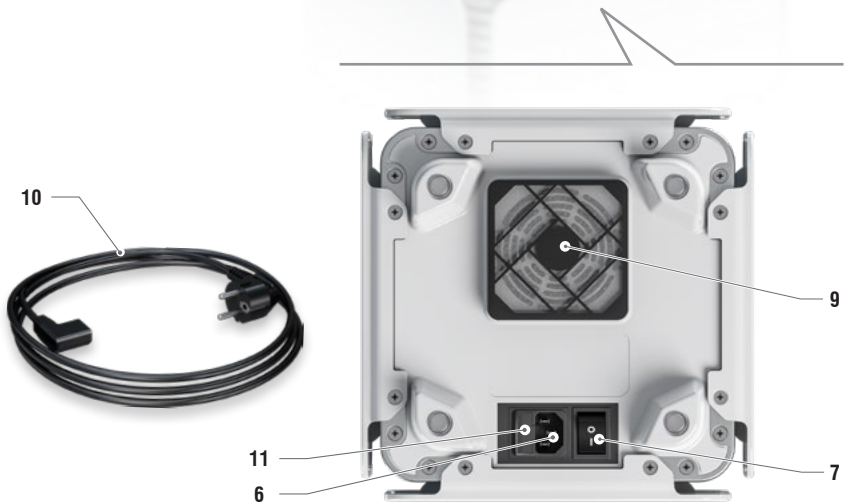
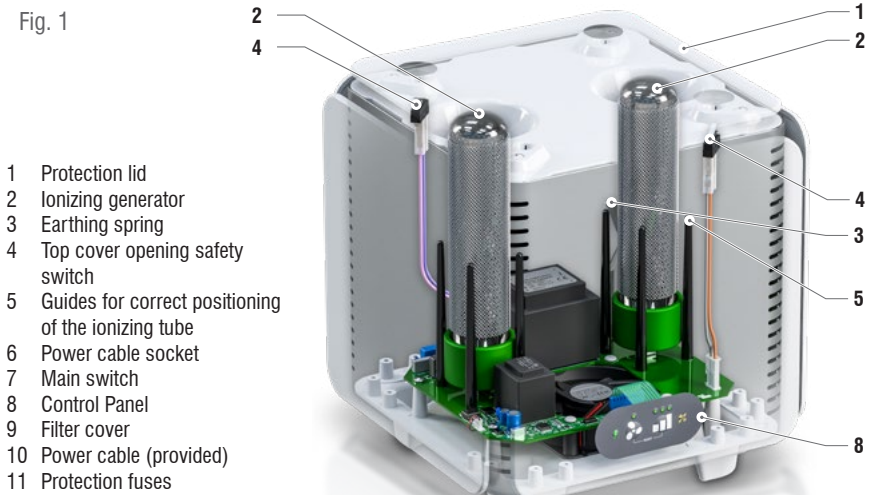
Fig. 1



4.1.1 Technical features JONIX cube

MODELS				
Code	70WHITECUBE	70BLACKCUBE	70WHCUBEIOT	70BKCUBEIOT
Plasma generators	2 x 175 mm type			
Generators replacement	every 8740 of actual operation of generators			
Generators maintenance	every 840 of actual operation of generators			
Dimensions	238 (L) x 238 (P) x 260 (H) mm			
Weight	3,5 kg			
Type of power supply	230 V / 1~ / 50 Hz			
Consumption	10 W			
Electrical absorption	51 mA			
Lp eq according to UNI-EN 3746*	33 dB (A)			
Ventilation type	1 axial fan with fixed flow rate			
Filter	Dust-proof SAE 304 stainless steel			
Air flow rate	40 m ³ /h			
Environments	from 110 to 240 m ³			
Colour	White	Black	White	Black

(*): Equivalent sound pressure values (Lp eq) at a distance of 1m according to UNI-EN 3746 (Determination of sound power levels and sound energy levels of noise sources by measuring sound pressure - Control method using an enveloping surface over a reflecting plane), obtained starting from the values of sound power (Lw) determined with the tests in a reverberation room.

4.1.2 Spare parts available on order

Code	Description	Notes
71KT000001	CUBE GENERATORS SPARE PART KIT	2 Ionising generators
JX40000001	CUBE POWER CABLE	3x0.75 cable, SP8848 schuko plug and 90° IEC60320 C13 connector
JX40000002	PROTECTION FUSE	1 quick blow glass fuse 5x20 1A 'F'

5 - RECEPTION, TRANSPORT AND STORAGE (BASIC and IOT version)

5.1 PACKAGING

The JONIX cube device is shipped in special protective packaging that must be kept intact until installation. The materials that were not installed for technical requirements are supplied with suitable enclosure secured to the inside or outside of the device itself.

The package includes:

- JONIX cube (with 2 ionizing tubes already installed).
- Power cord.



Fig. 2



5.2 HANDLING AND TRANSPORT

Unless otherwise agreed in writing in advance, no other material or goods shall be placed on top of the devices.



The carrier is responsible for securing the load on the means of transport.

JONIX S.p.A. declines any responsibility in case of damage caused by loads poorly transported by the carrier.



To handle the device, use appropriate means, in good condition and suitable capacity, depending on the weight, as required by Directive 89/391/EEC and subsequent amendments.



Please take great care while unloading and positioning the devices, to prevent damaging the casing or components. Always make sure that the load is stable. Avoid uncontrolled rotations. Lifting assistance must, if necessary, be carried out with rods, levers, grappling hooks without ever using hands alone.



During lifting and/or transport and/or handling operations, provide for appropriate signalling and confinement of the dangerous zone, signalling the prohibition of access to the dangerous zone by unauthorised personnel.

5.3 INSPECTION UPON RECEPTION

When you receive the device please check all its parts, in order to make sure that it has not been damaged during transport.

Any damage must be reported to the carrier, by filling in the relevant section on the delivery note and specifying the type of damage.



Any type of complaint must be sent in writing within eight days from receiving the goods.

5.4 STORAGE



In case of prolonged storage before installation, the device must be protected from dust, weather and kept away from heat and vibration. Do not allow the device to come into contact with corrosive substances.

JONIX S.p.A. declines all liability for damage due to poor handling, transportation and storage.

5.5 HANDLING DEVICE IN OPERATING CONDITIONS

JONIX cube device is easy movable in various environments, because it is provided with reduced dimensions (see Chapter 4 "Technical Data").

6 - INSTALLATION AND COMMISSIONING (BASIC and IOT version)



JONIX S.p.A. disclaims any liability for failure to comply with the safety and prevention standards as described below.

The Manufacturer also disclaims any liability for damage caused by improper use of devices and/or alterations carried out without prior authorisation.

6.1 SAFETY INSTRUCTIONS

- The device must be installed in strict accordance with the instructions contained in this manual.
- While performing installation, operate in full safety and in a clean environment clear of obstructions.
- During each phase of use and/or maintenance it is forbidden to operate wearing loose or dangling clothes, long loose hair, jewellery, chains and anything that could be a danger of entanglement.
- **Before switching the device on check the integrity of the various components and of the electrical mains to which it is connected, making sure that it is fitted with a circuit breaker upstream of the power line.**
- **Before putting the device into operation, check that the electrical system to which it is to be connected has an effective earthing system.**
- Do not service or clean the device without first unplugging it from the mains.
- Perform routine maintenance following the instructions in this manual or contact JONIX S.p.A. for assistance.
- Unscheduled maintenance and the replacement of damaged or worn parts must only be carried out by specialist personnel authorised by JONIX S.p.A..
- Spare parts must meet the requirements defined by JONIX S.p.A..
- Do not insert objects of any kind into the device, as coming into contact with live parts or electrical terminals may cause fires or electric shocks. In case of maintenance, check that you have removed all tools and objects before closing the panels and restarting the device.
- Comply with the laws in force in the country in which the device is installed, regarding the use and disposal of the packaging and products used for cleaning and servicing the device; you should also observe the recommendations given by the manufacturers of such products.
- In the event of decommissioning or disposing of the MIC device, follow the anti-pollution regulations set out by the country in which the device is installed.
- **Use only the power supply indicated on the nameplate. If you are not sure about the type of power supply available, ask your local retailer or electricity provider for assistance.**
- Do not spill water or other liquids on the device.
- Place the device so that the power cable cannot be stepped on and/or does not cause tripping.
- Do not connect the device to power supply outlets connected to any other electric utilities or devices.

- Do not touch the inside of the device, unless otherwise specified in the instructions contained in this manual.
- Never force the components when installing or performing maintenance operations: although it is built with high strength materials, the parts of the device can be damaged if handled incorrectly.
- Do not try to perform maintenance work on the device, except where specified in this manual. Opening or removing the outer casing may expose you to dangerous live parts or may involve other risks. All maintenance work must be carried out by specialized personnel authorized by JONIX S.p.A., except where specified in this manual.
- Do not tamper with or modify the device.
- Do not perform maintenance or other operations in low light and visibility conditions.
- Do not modify the functional and performance components of the device.
- Do not tamper with the safety devices.
- Do not use the device after maintenance without making sure it is safe. Check that all components are correctly restored before restarting it.
- Do not remove or make illegible the safety, hazard, and mandatory signs on the device.
- Do not use water or liquids to put out a fire.
- The device has slots and openings for ventilation, do not obstruct or cover them, even partially.
- Always leave the necessary space for ventilation in front of cracks and openings, as indicated in this manual.
- Do not pull the power cord and make sure it is not too taut when connecting the device.
- Keep the cord and device away from hot surfaces.
- Do not cover the cord with rugs or other similar items.
- Place the cord in a position away from trafficked areas to avoid the risk of tripping.
- Do not remove the plug by pulling on the cord. To perform this operation, hold the plug, not the cord.
- Extensions should not be used.
- Do not tamper with or modify the power cord.
- Use the power cord supplied with the device, do not use third party power cords.
- Switch off the device before disconnecting the plug.
- Unplug when the device is not used for a long time and rewind the cord securely to avoid the risk of tripping.
- Do not use the device near ovens, fireplaces, stoves or other high temperature heat sources.
- Do not use the device near naked flames.
- Place the device on a stable surface (avoid beds, sofas, blankets, carpets and so on).

- When using the product together with gas appliances in operation (such as gas stoves, gas water heaters, gas hobs, etc.), adequately ventilate the environment to avoid carbon monoxide poisoning.
- Do not use the device near air fresheners, essential oils, chemical additives and similar products.
- Disconnect the device from the power supply and contact JONIX S.p.A. or a dealer for service when any of the following cases occur:
 - the internal parts of the device have come into contact with water or other liquids of any kind;
 - a malfunction persists despite all the installation and/or maintenance procedures having been performed properly;
 - the power supply cable is damaged or worn.

Fig. 3



Do not pull the power cord.



Do not place it near heat sources.



Do not use naked flames.



Do not place in niches or closed spaces (allow a free space of at least 5 cm on each side).

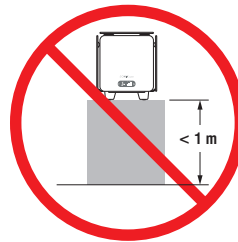

Do not place on the ground (keep the device at least 1m high).



IMPORTANT: Take into account and solve all the other types of risk that may be present. For example, risks arising from foreign bodies getting into the device or risks due to dangerous flammable or toxic gases at high temperature.



ATTENTION! Any use other than that specified herein shall be deemed to be incorrect.

6.2 GETTING STARTED



- Check that the various components of the device are fully intact.
- Check that the documentation and all components for installation are contained in the package.



- Do not rest weights or tools on the device, or place it on an unstable surface.

6.3 OPERATING SITE CHARACTERISTICS



The environment in which the device is placed must have the following characteristics:

- air temperature between 0°C and 40°C;
- relative air humidity below 80%.



- Do not place the device outside.
- Do not move the device by pulling the power cord.
- Turn off and unplug the device before moving it.



Do not place the device in environments where there are flammable gases, acidic, aggressive and corrosive substances that could damage it.



The device must not be installed in an explosive environment due to the presence of electrical and electronic equipment not specially designed.



Ensure **free spaces** around the device for the purposes of correct ventilation. If the device is placed on shelves or support surfaces, make sure there is **at least 5 cm of space** between the wall and the side of the device closest to it.

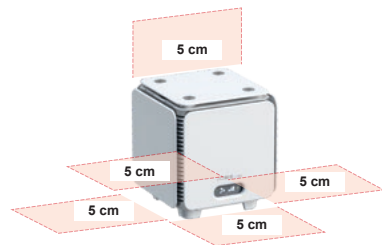

6.3.1 Position of the operator

During operation, the presence of the operator in the vicinity of the device is not required. For maintenance, the operator must access the top cover as shown in the figure.

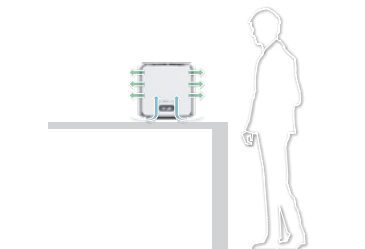

04

Fig. 4: Position of the operator for maintenance operations.

6.4 ELECTRICAL CONNECTIONS



ATTENTION! BEFORE STARTING ANY OPERATION, MAKE SURE THAT THE GENERAL POWER SUPPLY LINE IS DISCONNECTED AND THAT THE DEVICE CANNOT BE ACCIDENTALLY POWERED!

- The electrical connections must be carried out following the instructions provided in this manual.
- **Make sure that voltage and frequency of the electric line correspond to those provided on the name plate.**



ATTENTION!

Using a power supply that does not meet the requirements of the device may result in damage to the device or some of its parts.

- Connect the device to an effective earthing outlet.

6.5 ELECTRIC POWER SUPPLY

The JONIX cube device is ready for connection to the civil power supply network, 230V/1~/50Hz. The device is equipped with a cable with a Schuko plug. Do not use the device if the plug and/or power cord are damaged. Connect the plug only to a socket with the same technical characteristics. Periodically check the condition of the power cord.



Before making any connections, ALWAYS make sure the mains voltage complies with what is shown on the plate.



ATTENTION!

It is recommended to check that the energy delivered is stable. Otherwise a voltage stabilizer must be installed upstream.

6.6 USING THE DEVICE

The JONIX cube device has been designed to work in a user-friendly and immediate way, simply by connecting it to the power supply line with the cable provided.

Fig. 5: Remove the device from the packaging. Remove the protective film from the sides of the device.



Fig. 6: Connect the device to the mains using the power cable provided.



Fig. 7: The ON/OFF switch is located at the bottom of the device (see chapter 4). To power the device, on press the 0/1 button, switching it to 1.



 **The presence of high voltage inside the device is indicated by the relevant light, located on the front panel, when the device is switched on.**

JONIX cube BASIC

Fixed green LED: the device is on

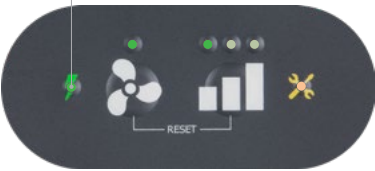

 **When the JONIX cube BASIC device is turned on, you will immediately hear a slight buzz.**

JONIX cube IOT

Fixed green LED: presence of electrical voltage

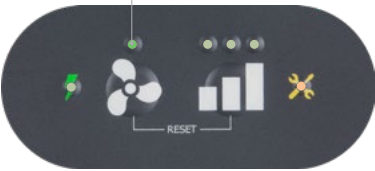

 **When you turn on the JONIX cube IOT, the device will be in stand-by mode.**

6.7 CONTROL PANEL JONIX cube (BASIC version)

The device control panel consists of:

- 2 control keys.
- 6 status indication LEDs.

The integrated control electronics allows operating the device at 3 different timing levels.

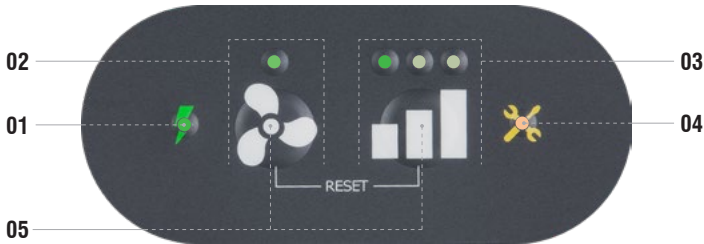

01 Power indicator LED	<ul style="list-style-type: none"> ● Device On ○ Device Off
02 Enable / disable the fan	<ul style="list-style-type: none"> ● Fan on ○ Fan off
<p>Timing level key Remark: the operating level is indicated by the corresponding led. To switch to the next level, press the push-button ■■■.</p>	<ul style="list-style-type: none"> ■■■ Enabling level I (minimum): 2' On – 8' Off ■■■ Enabling level II (average): 4' On – 6' Off ■■■ Enabling level III (maximum): 7' On – 3' Off
04 Maintenance Warning LED	<ul style="list-style-type: none"> ○ No warning ☀ Device cleaning required warning (every 840 of actual operation of the ionizing tubes) ● Ioniser replacement required warning (every 8740 of actual operation of the ionizing tubes)
05 Maintenance Warning Reset Key	<p>To reset, keep the keys ■■■ and ⚙ pressed for 5": all the LEDs will go off and the timer will be reset. When both keys are released, standard operation is resumed.</p>

6.7.1 Operating levels (BASIC version)

The operating level can be selected to meet the following requirements:

- the quantity of pollutants or odours present or produced in the room;
- if there is a need to carry out an intense sanitization activity (decontamination);
- if there are more people than usual;
- to quickly dispel any unpleasant smell;
- Depending on the size of the room, particularly:
 - Level I -> until 20 m²;
 - Level II -> 21 ÷ 50 m²;
 - Level III -> 51 ÷ 85 m².

Fig. 8: Press the ■■■ button to toggle between activation levels.



The operating level is indicated by the corresponding led above the symbol ■■■.

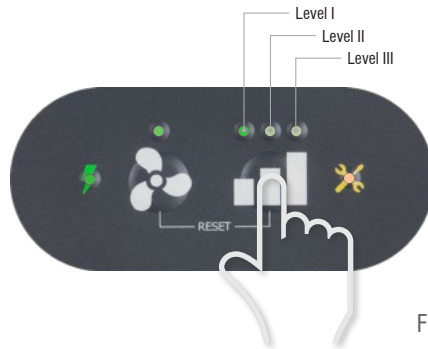

Fig. 8

6.7.2 Ventilation function (BASIC version)

The ventilation function is recommended to improve the air movement in the rooms, optimizing the positive effects of the device. It is possible to deactivate this function by reducing the noise without compromising the operation of the device.

Fig. 9: Press the ⚙️ button to activate or deactivate the ventilation function.



The activation of the ventilation is signaled by the corresponding LED lit above the ⚙️ symbol.



Fig. 9









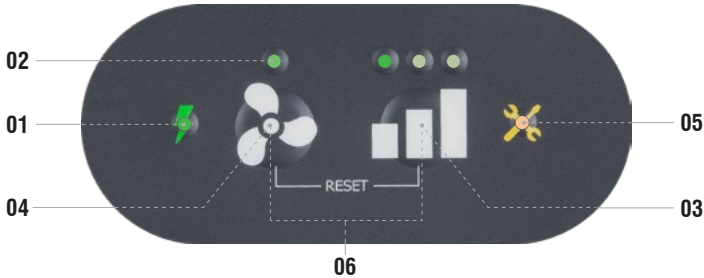

*) NOTE: for best performance, it is advisable to always keep the ventilation mode active.

6.8 CONTROL PANEL JONIX cube (IOT version)

The device control panel consists of:

- 2 control keys.
- 6 status indication LEDs.



01	Wi-Fi Led	<ul style="list-style-type: none"> ● Fixed green LED: Wi-Fi is connected. ◉ Flashing light: the device is connecting with Wi-Fi. NOTE: if the LED continues to flash it means that the device is unable to connect (see paragraph 7.6 "PROBLEMS AND SOLUTIONS"). ○ LED off: Wi-Fi is not configured.
02	Power indicator LED	<ul style="list-style-type: none"> ● Fixed green LED: presence of electrical voltage. NOTE: with the LED on, the device may be on or in stand-by mode. ○ LED off: device off.
03	<p>Timing level key By pressing the  key the device is switched on and the timing level 1 is activated. NOTE: Press the  button to switch from one activation level to another (the operating level is indicated by the corresponding LED lit above the  symbol). With the fourth press, the device returns to STAND BY status.</p>	<ul style="list-style-type: none">  Level I: 1' On – 4' Off  Level II: 2' On – 3' Off  Level III: 2' On – 1' Off
04	<p>Power key By pressing the  key the device is switched on and the timing level 1 is activated. When the device is switched on in one of the available timing levels and the  key is pressed again, the device returns to the STAND BY state.</p>	
05	Maintenance Warning LED	<ul style="list-style-type: none"> ○ No warning. ◉ Device cleaning required warning (every 840 of actual operation of the ionizing tubes). ● Ioniser replacement required warning (every 8740 of actual operation of the ionizing tubes).
06	Maintenance Warning Reset Key	To reset, keep the keys  and  pressed for 5": all the LEDs will go off and the timer will be reset. When both keys are released, standard operation is resumed.

6.8.1 Operating levels (IOT version)



The operating level can be selected to meet the following requirements:

- the quantity of pollutants or odours present or produced in the room;
- if there is a need to carry out an intense sanitization activity (decontamination);
- if there are more people than usual;
- to quickly dispel any unpleasant smell;
- Depending on the size of the room, particularly:
 - Level I -> until 20 m²;
 - Level II -> 21 ÷ 50 m²;
 - Level III -> 51 ÷ 85 m².



The JONIX cube IOT device allows you to manage timing levels from the App Controller (see the chapter "REMOTE MANAGEMENT WITH IOT SYSTEM").



It is also possible to manage the timing manually by pressing the button  to toggle between activation levels (the operating level is indicated by the corresponding LED lit above the  symbol).



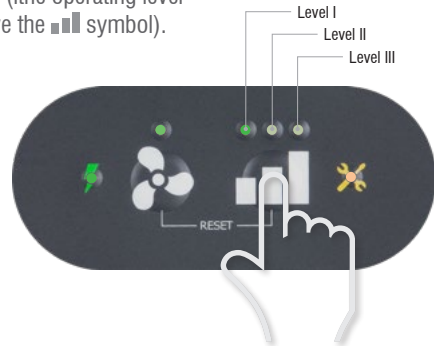

Note: With the fourth press, the device returns to STAND BY status. Pressing again the device turns on and activates level I.



6.8.2 Ventilation function (IOT version)

The ventilation function improves the air movement in the rooms, optimizing the positive effects of the device.



Note: the symbol  indicates that the device is equipped with ventilation. It is not possible to exclude ventilation while the device is operating. When the device is switched on in one of the available timing levels and the  key is pressed again, the device returns to the STAND BY state.

6.9 FIRST START CHECKS

At first start-up, the device should be subjected to at least the following checks:

- check the integrity and stability of the JONIX cube as a whole;
- check that the top cover is properly attached;
- check that the mains voltage is correct in relation to what is indicated on the nameplate of the device;
- check that on the display is off the orange led for the ordinary maintenance request (see paragraph 8.2 “ordinary maintenance”);
- check that the air flow is regular;
- check that you can hear the slight sizzle of the ionizing tube.



Repeat the checks carried out at the first start-up even after each extended shutdown period and after maintenance.

7 - REMOTE MANAGEMENT WITH IOT SYSTEM

7.1 INTRODUCTION

The management with the IOT system is used to remotely control Jonix devices via the Jonix Controller App. The user can add devices, view the list of their devices and contact technical support. From the device detail page it is possible to perform actions such as turning the device on or off, setting of the ionisation level, performing of the weekly programming of your device and viewing of the need for maintenance of the device by means of the count that states how many hours remain before cleaning and replacement operations are required. User registration is required in order to interact with devices through the Jonix Controller app.



Download the Jonix Controller App from the App Store or Google Play (Check compatibility with the mobile device). Once installed on your smartphone, it is possible to proceed to the configuration phase.



To connect the device to the Wi-Fi network, the router must not have any filter blocks set. In case of connection problems, contact your system administrator.

*: Versions of Android and iOS with which the Jonix Controller application is compatible:
OS Android: Android 6.0 and later versions. | iOS: iOS 11.0 or later version.

Bluetooth: Bluetooth BLE. | WiFi: WiFi 2.4 GHz.

To install Jonix Cube IoT devices in a network with a certain degree of protection (for example, with firewalls), it is necessary to enable the ICMP protocol towards the outside and the opening (always towards the outside) of the TCP and UDP ports:

- For the TCP protocol: 443 (FOTA) and 80 (HTTP).
- For the UDP protocol: 123 (NTP), 68 (DHCP), 67 (DHCP) and 53 (DNS).

7.2 REGISTRATION AND LOGIN

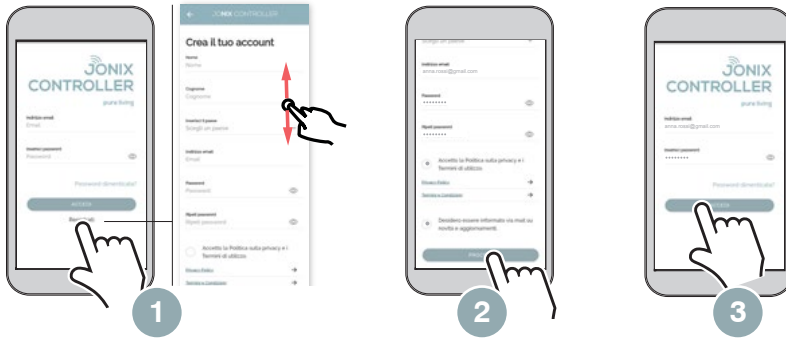

1 Launch the Jonix Controller App. Press "Register". Fill in the fields with the required information.

2 Once the fields have been filled in, press "Continue". **Check your mailbox to confirm your registration.**

3 Access by "Login" using the Mail and Password defined during registration.

7.2.1 Main screen (without associated device)

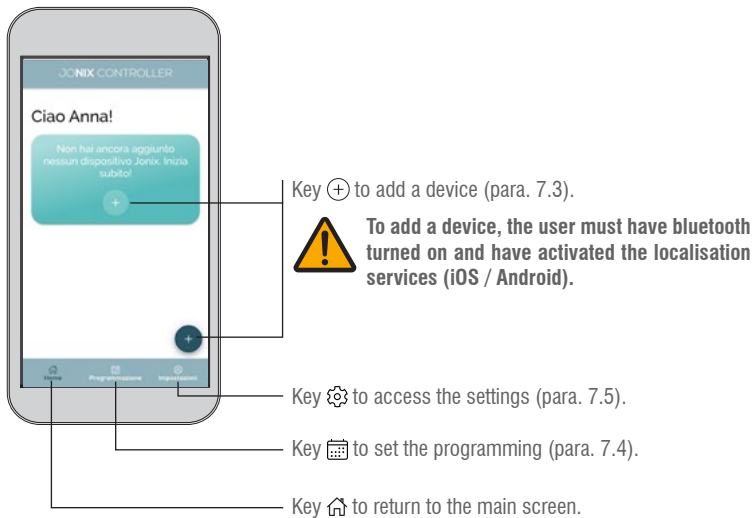

7.3 DEVICE ASSOCIATION

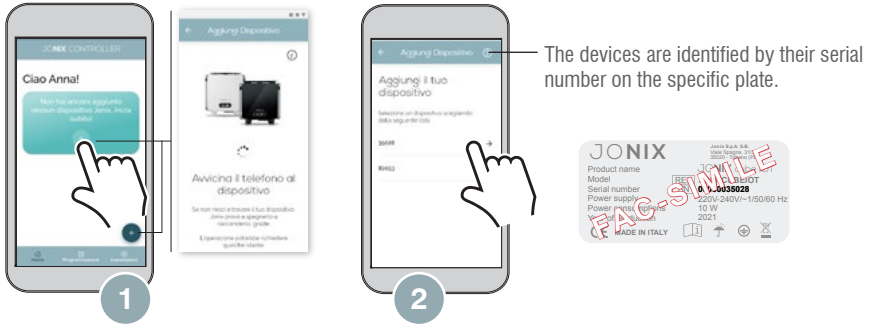

Press the key \oplus to add a device.

Select the corresponding device code to enter the wi-fi network information screen. Enter the network parameters and connect the device.

When selecting the Wi-Fi network, the user can choose whether to manually enter the network name or to use the plugin to scan the QR code of their router.

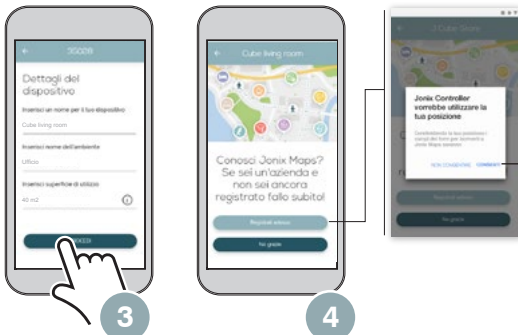
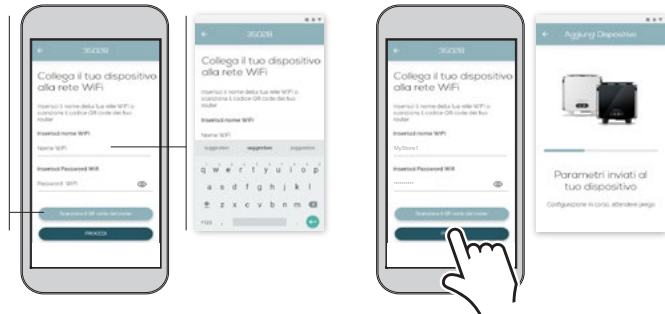

Once the fields have been filled in, press "Continue".

By pressing the "Register now" button, the user can subscribe to Jonix Maps, the Jonix App that geolocates commercial activities.

7.3.1 Main screen (with associated device)

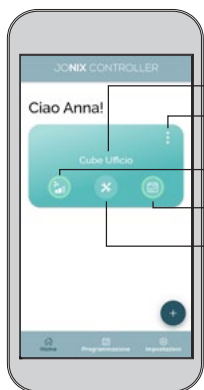

Name associated with the device.

Key ; to access device information.

Key to select the device timing level.

Key to access the specific programming of the device.

Key to access the device maintenance.

Once connected, the device will appear in Home. The status of the device (on/off and timing level) will correspond to the settings set manually via the keypad on the device.

7.3.2 Virtual buttons

The user can check the operating status of the device at any time using the virtual buttons, in particular:

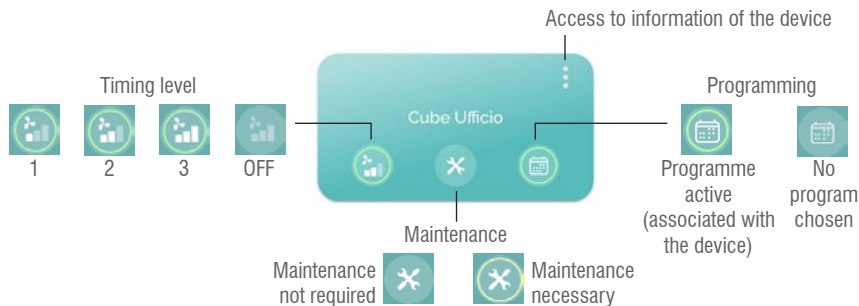

7.3.2.1 Timing level

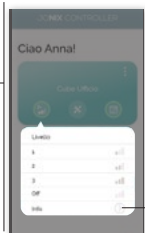

Press to display information useful for choosing the ideal timing level.



In the event that there is an active programming associated with the device and the level is changed manually, operation will remain so until the next scheduled level change.

7.3.2.2 Maintenance Status

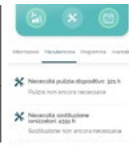

- ✗ **Necessità pulizia/dispositivi più in** — Counter showing the hours remaining until the device must be cleaned. (Pulizie non ancora realizzate)
 - ✗ **Necessità sostituzione** — Counter showing the hours remaining until the ionisers must be replaced. (Sostituzione non ancora realizzata)
- Pressing (✗) it is possible at any time to view the hours remaining until scheduled maintenance (cleaning and replacement).

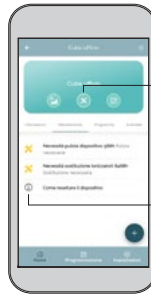

Once the counter reaches zero, the wording "Cleaning required"/"Replacement required" will be displayed; the maintenance icon (✗) will be activated to notify the user of the need to perform maintenance on the device (cleaning and/or replacement).

Press (i) to view information on how to reset the device. Once the reset has been performed, the IoT will send the timing reset to the App which will restart with the countdown.



For further information on performing maintenance on and resetting the device, see chapter 8.

7.3.2.3 Programming Status

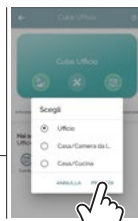



If no program is activated, press the symbol (⊕) to access the set programmings screen. Select the desired program and confirm the choice with the "Continue" button.





Once the program has been selected, the user can use the pre-set functions or customise the parameters (switching on, switching off, timing levels, days, time slots).

Key  to access the screen with the details of the program associated with the device.

Key  to remove the previously selected program.

Key  to change the choice of programming.



Key  to delete the selected program.

Key  to copy the selected program.

Key  to change the selected program.

7.4 PROGRAMMING

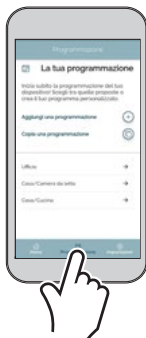

On the programming page the user can:

- create a new programming;
- copy an existing programming;
- modify one of the programmings proposed by the App (see paragraph 7.4.2.3 "Programming Status").

7.4.1 Adding a programming



Follow the instructions on the various screens to set the customised parameters and to save the programming.

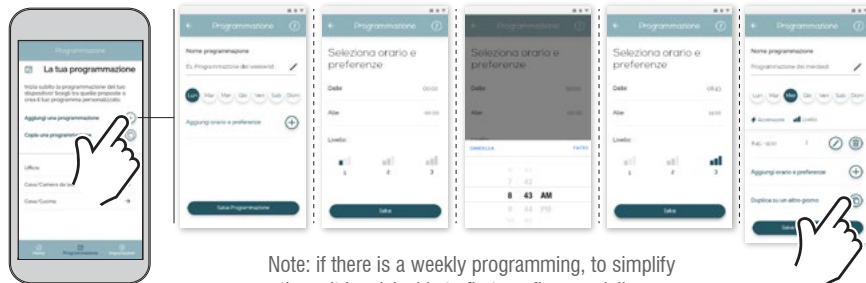

Note: if there is a weekly programming, to simplify operations, it is advisable to first configure a daily program and then press the "Duplicate another day" function .

7.4.2 Copying a programming



The user can copy a programming already present on the device. In this way it is possible to duplicate the days, times and preferences present in the existing programming and, if necessary, to edit the current programming.

7.5 SETTINGS

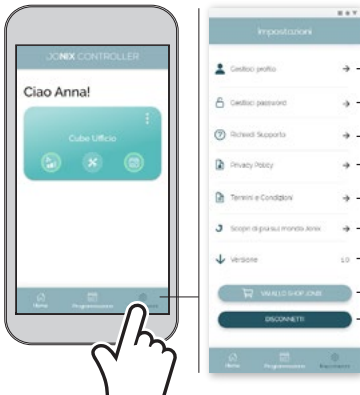

→ Access to the user profile data management.

→ Access to the user password management.

→ Access to the Jonix support form.

→ Access to the "Privacy Policy" screen.

→ Access to the "Terms and Conditions" screen.

→ Access to the up-to-date information with the Jonix Blog.

→ App version.

→ Access to the "Jonix Shop". screen.

→ User log off key.

7.5.1 Information Screen

Press **ⓘ** to access the detailed device information screen.

Press **?** to display information useful for choosing the ideal timing level.

Pressing **✂** it is possible to modify:

- the name of the device;
- the name of the environment
- the usable surface.

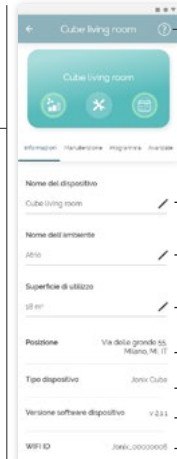

- Device name (editable).
- Environment name (editable).
- Use surface (editable).
- Registered location (shared with the App).
- Device type.
- Device software version.
- WIFI ID.

7.5.2 Maintenance Screen

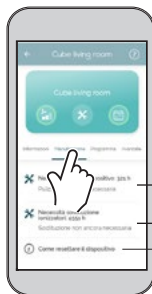

- Counter showing the hours remaining until the device must be cleaned.
- Counter showing the hours remaining until the ionisers must be replaced.



By pressing the "Info" key, the user can view a popover with useful tips to perform the reset by pressing the keys on the keypad of the Jonix cube IoT device.

7.5.3 Program Screen

Key to change the choice of programming.

Key to remove the previously selected program.

Key to access the screen with the details of the program associated with the device.

7.5.4 Advanced Screen

Press to unpair the device and to restore the factory settings.

Press to reconfigure the associated wi-fi network.

Press to view the use and maintenance manual.

7.6 TROUBLE-SHOOTING

If at the time of access, the access password has been forgotten, press the "Forgot password?" key.

- 1) Enter the e-mail used for registration in the "E-mail" and "Confirm e-mail" fields and press the "Proceed" key.
- 2) To confirm the operation, press the "Proceed" key of the popup.



In the e-mail box, check for the presence of the e-mail with the new password. Also possibly check the "Junk mail" or the SPAM folder. Note: once logged in, the password can be changed (paragraph 7.5 "SETTINGS").



Device not connected!

- 1) Check that the device is on.
- 2) Check that the WI-FI router is turned on and that its settings have not changed.
- 3) Reconfigure WI-FI.
- 4) Turn the Jonix device off and on again.



Attention! Unable to connect to the network!

- 1) Check the parameters entered.
- 2) Check that the WI-FI router is turned on and that its settings have not changed.

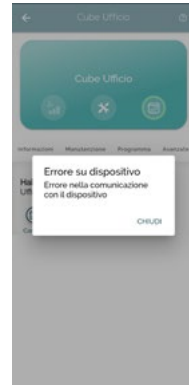

Device error!

- 1) Check that the WI-FI router is turned on and that its settings have not changed.
- 2) Turn the Jonix device off and on again.



Oops! An error has occurred.

- 1) Check the network connection.
- 2) Check that the WI-FI router is turned on and that its settings have not changed.



The session has expired!

- 1) Log in again.

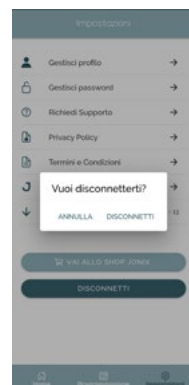

Do you want to disconnect?

- 1) Press "Cancel" to continue browsing the App.
- 2) Press "Disconnect" to exit the App.

8 - MAINTENANCE (BASIC and IOT version)

8.1 WARNINGS



BEFORE CARRYING OUT ANY MAINTENANCE OPERATION MAKE SURE THAT THE DEVICE IS NOT AND CANNOT ACCIDENTALLY BE POWERED ELECTRICALLY. YOU MUST THEREFORE UNPLUG THE DEVICE BEFORE CARRYING OUT ANY MAINTENANCE.

- It is the duty of the user to perform all the maintenance operations on the device listed below.
- In the event of a malfunction not indicated in this manual, disconnect the device from the power supply and consult your dealer and / or JONIX S.p.A.
- Only specialised personnel authorized by JONIX S.p.A., can perform maintenance operations other than those specified in this manual.



For all maintenance operations it is good practice to use work gloves to protect your hands.

The frequency of the operations to be performed to ensure proper maintenance of the device JONIX cube depends mainly on the quality of the treated air. Air can be especially harmful for device when it contains polluting or aggressive substances such as:

- Industrial flue gas
- Sale
- Chemical smoke
- Heavy powders



By coming into contact with the inside or outer surfaces of the device by means of the air flow or by direct exposure, these substances can lead to a structural and functional failure of the device and of its performance as time passes and without proper, systematic maintenance.

8.2 ROUTINE MAINTENANCE

The JONIX cube needs a reduced maintenance which consists of periodic and regular cleaning or replacement of the non-thermal plasma generator (ionizing tube), cleaning or replacement of the filter and checking the correct operation of the fan.

The JONIX cube signals the need for maintenance of the non-thermal plasma generator (ionizing tube) by turning on the "maintenance led" (orange led):

- orange led flashing fast -> cleaning the ionizing tube (see paragraph 8.2.1 "Cleaning ionizing tubes").
- orange led always on -> replacement the ionizing tube (see paragraph 8.2.4 " Replacement ionizing tubes").



For all maintenance operations it is good practice to use work gloves to protect your hands.

8.2.1 Cleaning ionizing tubes

The JONIX cube signals the need for cleaning of the ionising tubes, through the indicator light shown on the display (orange led), every 840 hours of operation.

However, when operating in highly contaminated environments, the electronics of the device could intervene even if this time has not yet elapsed.



Clean the ionising tubes whenever the corresponding LED starts blinking.

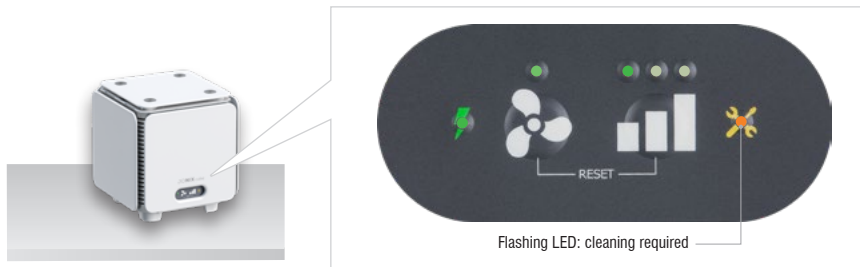

Fig. 10: Switch the ioniser off by switching the On/Off button to **0**. Put the device on a flat surface. Remove the plug connected to the mains.



Fig. 11: Remove the lid by pulling it upwards.



Fig. 12: Gently unscrew the ionising tubes by acting on the glass surface that can be reached by hand through the special slots.



Fig. 13: Pull off the outer mesh from the tube. If this is difficult to do, turn the mesh around the glass while pulling to remove it.



Check that the ionizing tube is in good conditions: there must not be any cracks or other damage; otherwise it must be replaced.

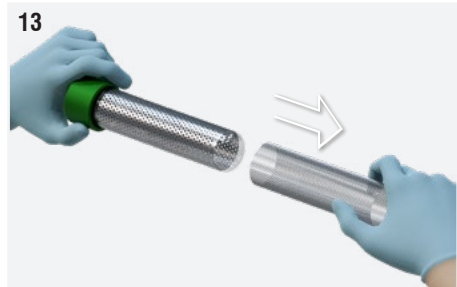

Fig. 14: Clean the glass using a damp cloth.



Do not use liquid cleaners, sprays, soap or other products.





The presence of a whitish layer on the perforated metal sheet inside the glass indicates the need to replace the pipe. **The tube must usually be replaced within 18 months of use.**

Fig. 15: Wash the mesh under running hot water and dry it thoroughly with a non-fraying cloth.



Do not put back the mesh on the ionising tube if it is even partially wet.

Fig. 16: Put the outer metal mesh back on the glass tube so that it fully overlaps the internal plate.

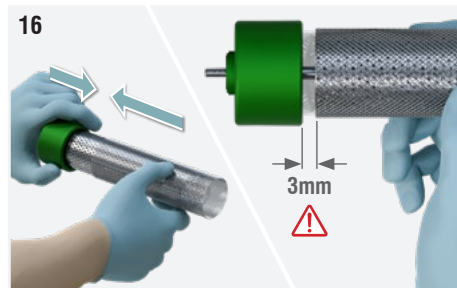

In any case ensure a minimum distance of at least 3 mm from the base of the tube.

Fig. 17: Screw the ionizing tubes back into place by acting again on the glass surface that can be reached by hand through the special slots.



ATTENTION: do not overtighten the screw after reaching its end stop.

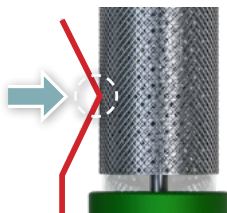

Once the ionising tubes have been screwed back into place, the earthing spring is in contact with the outer mesh. Otherwise contact the manufacturer.

Fig. 18: Put the lid back on the device by pushing it until the parts are locked in place.

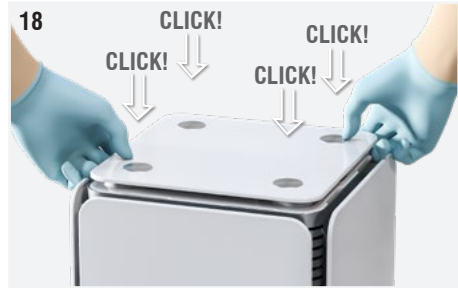

Fig. 19: Reconnect the plug. Switch the ionising device on by switching the On/Off button to I.



The presence of high voltage inside the device is indicated by the relevant light, located on the front panel, when the device is switched on.

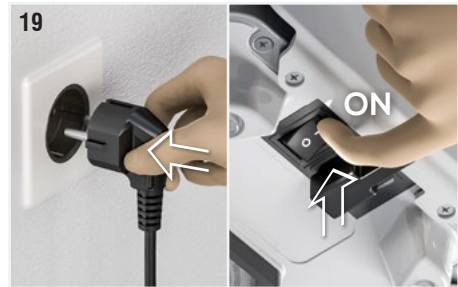
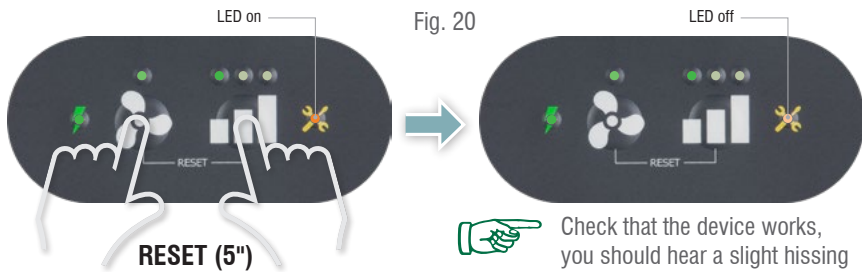

Fig. 20: To reset, keep the keys  and  pressed for 5" until maintenance LED will go off.



The ionising tubes can be re-enabled only after the light has gone off.



In the event that a device malfunction persists, disconnect the device from the mains and contact qualified staff authorized by the manufacturer.



Failure to clean the ionizing tube when indicated by the device leads to a drop in system performance.

7.2.2 Cleaning the filter

Clean the filter at the bottom of the device during every ionizing tube maintenance operation.



In the case of rooms with high quantities of dust, it is advisable to reduce the time required to maintain the device in operation and remove traces of dust and residues that obstruct the air flow.

Fig. 21: Switch the ioniser off by switching the On/Off button to **0**. Remove the plug connected to the mains.



Fig. 22: Remove the filter cover by pressing the sides and pulling towards you.

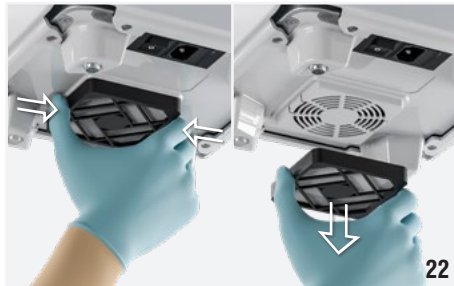

Fig. 23: Wash the mesh filter under running water and dry it with a microfibre cloth.



Fig. 24: Use a damp microfibre cloth to wipe the plastic filter cover and the grid incorporated in the closing plate.



Fig. 25: Put the mesh filter back into the filter cover. Reassemble the filter cover with the snap fastening. Press it on the grid incorporated in the closing plate until you feel the snap of the coupling between the parts.



Fig. 26: Reconnect the plug. Switch the ionising device on by switching the On/Off button to I.



The presence of high voltage inside the device is indicated by the relevant light, located on the front panel, when the device is switched on.

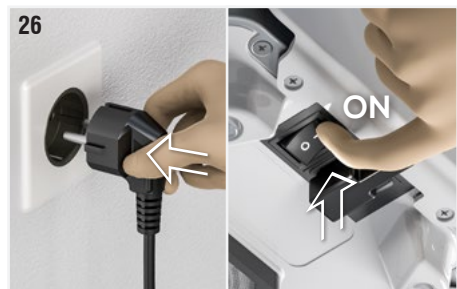

8.2.3 External cleaning of the device

Fig. 27: Clean the outside of the device with a damp cloth.



Do not use liquid cleaners, sprays, soap or other products directly on the device.



Pay particular attention to the air passage grid: check that they are not dirty to ensure air passage.



8.2.4 Replacement ionizing tubes

The ionizing tube is the component of the device that has deteriorated over time to the point where it needs to be replaced. Components must be replaced when signs of wear appear, indicated by oxide on the internal mesh of the condenser, which will make it turn white, and by the glass looking dull. The JONIX cube signals the need for replacement of the ionising tubes, through the indicator light shown on the display (orange led), every 8740 hours of operation. However, when operating in highly contaminated environments, the electronics of the device could intervene even if this time has not yet elapsed.



Replace the ionising generators as soon as the relevant LED stays on permanently.

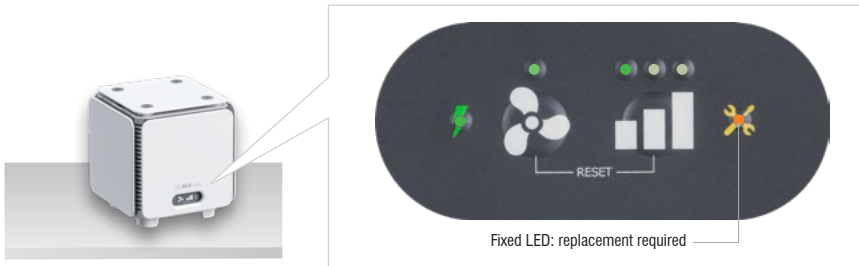

Fig. 28: Switch the ioniser off by switching the On/Off button to **0**. Put the device on a flat surface. Remove the plug connected to the mains.



Fig. 29: Remove the lid by pulling it upwards.



Fig. 30: Gently unscrew the ionising tubes by acting on the glass surface that can be reached by hand through the special slots.



Fig. 31: Unpack the new ionizing tubes from their packaging, handling them carefully as they are fragile.



The codes for ordering components subject to wear are given in paragraph 4.1.2 "Spare parts available on order".

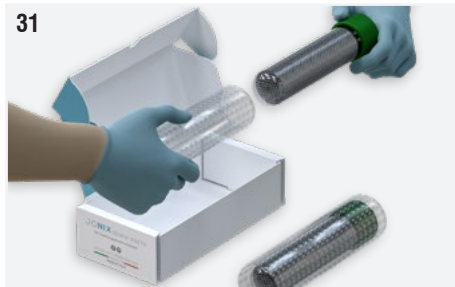
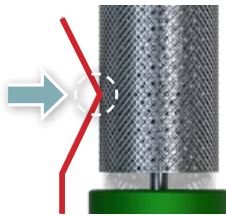

Fig. 32: Screw the **new ionizing tubes** back into place by acting again on the glass surface that can be reached by hand through the special slots.



ATTENTION: do not overtighten the screw after reaching its end stop.



Once the ionising tubes have been screwed back into place, the earthing spring is in contact with the outer mesh. Otherwise contact the manufacturer.

Fig. 33: Put the lid back on the device by pushing it until the parts are locked in place.



Fig. 34: Reconnect the plug. Switch the ionising device on by switching the On/Off button to I.



The presence of high voltage inside the device is indicated by the relevant light, located on the front panel, when the device is switched on.

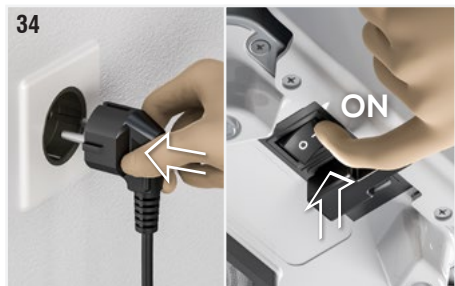
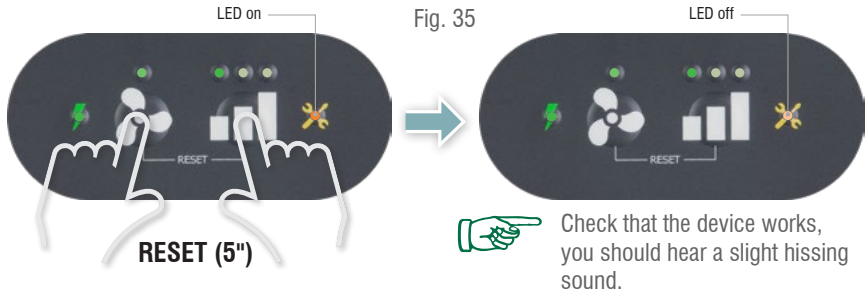

Fig. 35: To reset, keep the keys  and  pressed for 5" until maintenance LED will go off.

 **The ionising tubes can be re-enabled only after the light has gone off.**



 **In the event that a device malfunction persists, disconnect the device from the mains and contact qualified staff authorized by the manufacturer.**

 **Failure to replacing the ionizing tubes when indicated by the device leads to a drop in system performance.**

8.2.5 Replacement of the protection fuse

Fig. 36: After disconnecting the power supply to the device, remove the fuse holder located next to the socket.

Remove the fuse (1) from the fuse holder: if it is blown, replace it with the spare fuse (2) supplied. Place the fuse holder in its seat and restore the device power supply.

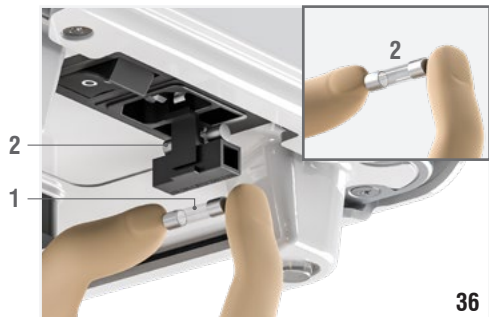

8.3 SPECIAL MAINTENANCE

 **Any maintenance that does not fall within the operations described as routine maintenance must only be carried out by specialist personnel authorised by JONIX S.p.A.. Contact distributor, dealer or JONIX S.p.A..**

9 - CHECKING OPERATION AND POSSIBLE FAULTS (DIAGNOSTICS)

This section summarises the most common problems that may arise when using the unit. Before contacting customer service, make the checks described in the paragraph on diagnostics and check that the "maintenance led" (orange led) is not on.

9.1 DIAGNOSTICS (BASIC and IOT version)

PROBLEM	POSSIBLE CAUSE	SOLUTION
The green LED indicating device operation is switched off.	Lack of power to the device.	Check that the 0/I switch is in position I.
		Check that power is present in the distribution mains.
		Check that the socket the device is connected to is working.
		Check that the plug is firmly connected to the outlet.
		Check that the lid is fitted properly and locked into place.
		Verify that the protection fuse isn't burnt. Follow the instructions in section "8.2.5 - Replacement of the protection fuse".
		Check that power is present in the distribution mains.
You can't hear the ionizer sizzle.	Need for maintenance to the ionizing tube.	Follow the instructions in section "8.2 - ROUTINE MAINTENANCE".
	Ionizing tube failure.	Follow the instructions in section "8.3 - SPECIAL MAINTENANCE".
Air ionization does not meet expectations (lack of ionizing effect in the air).	Need for maintenance to the ionizing tube.	Follow the instructions in section "8.2 - ROUTINE MAINTENANCE".
	Fan failure.	Follow the instructions in section "8.3 - SPECIAL MAINTENANCE".
The orange LED that indicates that maintenance is required is blinking.	The ionising tubes and fan mesh filter need cleaning.	Follow the instructions in section "8.2.1 - Cleaning ionizing tubes" and "8.2.2 - Cleaning the filter".
The orange LED that indicates that maintenance is required is on and steady.	The ionising tubes need replacing.	Follow the instructions in section "8.2.4 - Replacement ionizing tubes" and "8.2.2 - Cleaning the filter".
No sizzling noise comes from inside the device and the orange LED that indicates that maintenance is required is off.	Ionizing tube failure.	Follow the instructions in section "8.3 - SPECIAL MAINTENANCE".

9.2 DIAGNOSTICS (IOT version)

PROBLEM	POSSIBLE CAUSE	SOLUTION
The green LED indicating the device connection to the Wi-Fi network has been flashing for too long.	The device cannot connect to the Wi-Fi network.	Follow the instructions in paragraph "7.6 - PROBLEMS AND SOLUTIONS". If it doesn't work, follow the instructions in section "8.3 - SPECIAL MAINTENANCE".
The green LED, indicating the device's connection to the Wi-Fi network, is off.	The Wi-Fi network has not been associated with the device.	Proceed with the configuration of the wi-fi network as indicated in paragraph "7.3 – DEVICE ASSOCIATION".

9.3 GENERAL DIAGNOSTIC PROVISIONS



If a malfunction other than that described above occurs, contact a Dealer, a Distributor or JONIX S.p.A. (support@jonixair.com) and always quote the part number and serial number on the plate of the device.

Fig. 37: Disconnect the power supply to the device and contact JONIX S.p.A. or a dealer for assistance also when:

- the power cord is damaged or deteriorated;
- the power plug is damaged or deteriorated;
- water or liquid has been spilled on the appliance.



- a malfunction persists even though all the procedures described in this use and maintenance manual have been carried out correctly.

10 - DISPOSAL

When the JONIX devices are no longer used they must be disposed of in compliance with the regulations in force in the country of installation. The devices consists of the following materials:

- Stainless steel.
- Aluminium.
- Glass.
- Nylon.
- Plastic.
- Paper and Cardboard.
- Wood.
- Sintered expanded polystyrene.
- Copper.



MANAGEMENT OF WASTE ELECTRICAL AND ELECTRONIC EQUIPMENT

This product falls within the scope of Directive 2012/19/EU on the management of waste electrical and electronic equipment (WEEE). The appliance must not be disposed of with household waste as it consists of various materials that can be recycled at appropriate facilities. Inform yourself through your local authority as to the location of the ecological platforms for receiving the product for disposal and its subsequent proper recycling. The product is not potentially dangerous for human health and the environment, as it does not contain harmful substances as per Directive 2011/65/EU (RoHS), but if left in the environment it has a negative impact on the ecosystem. Read the instructions carefully before using the unit for the first time.

It is recommended that the product should not be used for any other purpose than that for which it was intended, as there is a risk of electric shock if used improperly.

jonixair.com

JONIX Spa
Benefit Corporation

info@jonixair.com
jonixsrl@legalmail.it



Registered Office
Viale Spagna 31/33
35020 Tribano (PD) – Italy
Ph. +39 049 9588511
Fax +39 049 9588522

Operational Headquarters
Via dell'Artigianato, 1
35020 San Pietro Viminario
(PD) – Italy
Ph. +39 0429 760311

Research and Development Headquarters
Via Tegulaia 10/b
56121 Pisa – Italy
Ph. +39 050 985165